

ANSCHÜTZ

EINFACH EINS WERDEN!

1761 APR



MANUAL

MODEL

1761 APR

J.G. ANSCHÜTZ GmbH & Co. KG
Jagd- und Sportwaffenfabrik

Daimlerstraße 12 · 89079 Ulm / Germany
Fon +49 - (0)731- 40 12 - 0 | Fax +49 - (0)731- 40 12 - 700



www.anschuetz-sport.com



www.facebook.com/OfficialAnschuetz



www.instagram.com/AnschuetzGmbH



www.youtube.com/AnschuetzGmbH

Stand 06 | 2023

CONTENTS

1. COMPONENTS / DEFINITIONS	4	8.6. BARREL / BARREL THREAD	21
2. INTRODUCTION	5	8.6.1. Dismounting / mounting the barrel thread	21
3. SYMBOLS USED	5	8.6.2. Maintenance of the barrel	21
3.1. GENERAL NOTES	5	8.6.2.1. Cleaning the barrel	21
3.2. SAFETY NOTES	5	8.7. SIGHTS / MOUNTING	22
4. GENERAL HANDLING OF GUNS	6	8.7.1. Mounting a Picatinny rail	22
4.1. IMPORTANT PRINCIPLES	6	9. MAINTENANCE / CLEANING	23
4.2. SHOOTING	7	9.1. GENERAL	23
4.3. MAINTENANCE	8	9.2. MAINTENANCE INTERVALS	24
4.4. TRANSPORT	8	9.2.1. Before shooting	24
4.5. STORAGE	8	9.2.2. After shooting	24
4.6. EAR AND EYE PROTECTION	8	9.2.3. Annually	24
5. LAWS	8	10. TROUBLESHOOTING	25
6. PROPER USE	8	11. DISPOSAL	25
7. LIABILITY	8	12. MISCELLANEOUS	25
8. PRODUCT-SPECIFIC HANDLING	9	13. SHOOTING PERFORMANCE	25
8.1. BOLT	9	14. GUARANTEE CARD	26
8.1.1. Cocking the bolt	9		
8.1.2. Inserting the bolt	10		
8.1.3. Removing the bolt	10		
8.1.4. Maintenance of the bolt	11		
8.1.4.1. Components/definitions	11		
8.1.4.2. Disassembling the bolt	11		
8.1.4.3. Removing the firing pin	12		
8.1.4.4. Assembling the bolt	12		
8.1.4.5. Maintenance intervals for the bolt	13		
8.2. SETTING/RELEASING THE SAFETY	13		
8.2.1. Setting the safety	13		
8.2.2. Releasing the safety	13		
8.3. LOADING/REPEATING/SHOOTING/UNLOADING	13		
8.3.1. Loading the magazine	13		
8.3.2. Repeating	15		
8.3.3. Ready to fire	15		
8.3.4. Unloading/making ready for storage	16		
8.4. TRIGGER	18		
8.4.1. Single stage 5061 D APR and two stage trigger 5061 APR	18		
8.4.2. Setting the trigger	18		
8.4.2.1. Adjusting the trigger blade	18		
8.4.3. Maintenance of the trigger	18		
8.4.4. Checking the trigger fastening	18		
8.5. BARRELED ACTION MOUNTING AND STOCK SETTINGS	19		
8.5.1. Components / definitions	19		
8.5.2. Mounting / dismounting the stock and barreled action	19		
8.5.3. Stock adjustments	19		
8.5.3.1. Adjustment of the butt plate	19		
8.5.3.2. Adjustment of the cheek piece	20		
8.5.3.3. Change grips	20		
8.5.4. Maintenance / cleaning of the stock	20		

1. COMPONENTS / DEFINITIONS

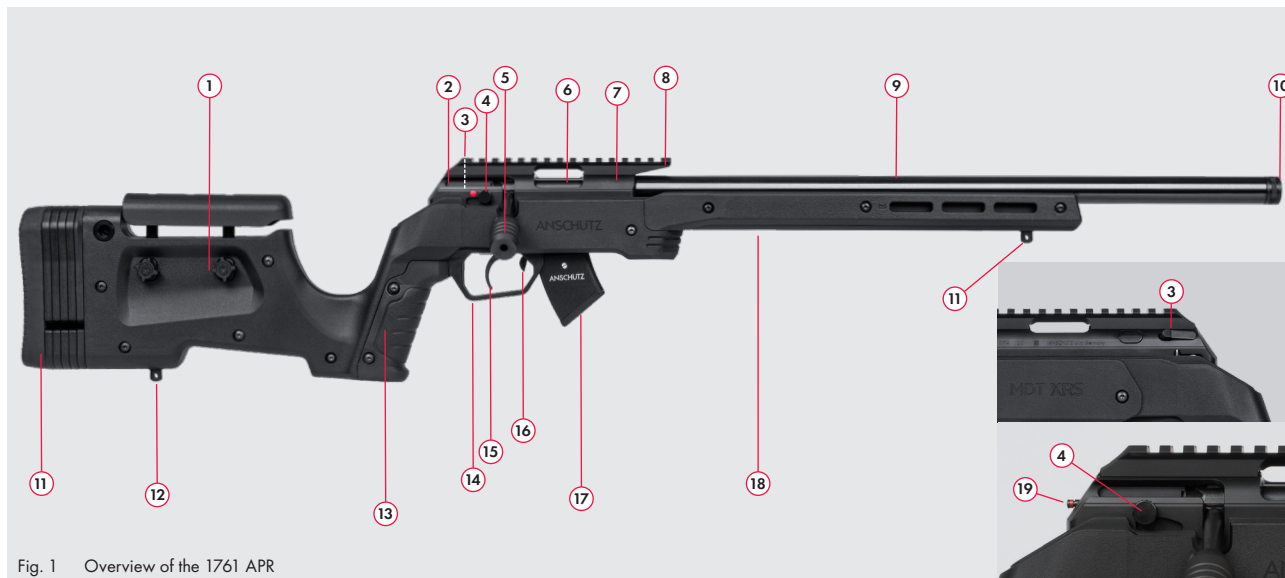

Fig. 1 Overview of the 1761 APR

- | | | | |
|------------------|---|---|--|
| 1. MDT XR Stock | 7. Receiver | 11. Adjustable rubber butt plate | 16. Magazine release lever |
| 2. Bolt | 8. Picatinny rail
with 30 MOA pre-tilt | 12. Sling swivel studs | 17. Magazine |
| 3. Bolt catch | 9. Barrel | 13. Rubberized grip,
interchangeable | 18. Fore-end with M-Lock
mounting options |
| 4. Safety | 10. Muzzle with thread
½"-28 UNEF | 14. Trigger guard | 19. Indicator pin |
| 5. Bolt handle | | 15. Trigger | |
| 6. Ejection port | | | |

! NOTE:



Your rifle may differ from the product depicted since this varies depending on model and equipment.

! NOTE:



The technical data do not apply to the entire model range. Specific model data may be found at www.anschutz-sport.com

2. INTRODUCTION

Dear Friend of ANSCHÜTZ:

You must be able to rely on a rifle's good qualities.

For example, its exact, consistent shooting performance. The ANSCHÜTZ barrels and detailed, sophisticated bolt construction guarantee you the best gunsmith quality.

ANSCHÜTZ incorporates more than 160 years' experience into its manufacturing of precision rifles. But of course tradition isn't everything. You will always be well-equipped with absolutely reliable, easy-to-handle ANSCHÜTZ rifles.

Our hunting and target rifles are highly complex, coordinated systems. If you are not sure of how to operate and safely handle firearms, please ask us or your specialized dealer to prevent any possibly expensive repairs.

We have put various instruction manuals and possible settings for our products on our YouTube channel www.youtube.com/AnsuetzGmbH.

You can always count on the first-class quality of an ANSCHÜTZ rifle. Your ANSCHÜTZ rifle will always be a reliable companion with unmatched accuracy and function.

Your ANSCHÜTZ team

3. SYMBOLS USED

In these Manual, the following symbols are used for general and especially important details:

3.1. GENERAL NOTES

- ▶ Identifies an action instruction
- ✓ Identifies the result of an action
- Identifies a list
- ↪ Identifies a note/additional information

3.2. SAFETY NOTES

- ⚠ Identifies a safety note

! OBSERVE!



Observe the instructions for use

! NOTE!



Prohibition that prescribes particular behavior

! NOTE!



Hearing protectors should be used for your safety!

! NOTE!



Eye protection should be used for your safety!

⚠ CAUTION!



Indicates a dangerous situation that can cause bodily injuries, property damage or death.

4. GENERAL HANDLING OF GUNS

Guns can be dangerous objects, whose storage and use require particular caution. The following safety notes and warnings must absolutely be followed!

NOTE!



Before using a firearm, you must absolutely read all of the Manual. You may only give the firearm to someone else with these Manual.

NOTE!



The firearm laws of the country in question are authoritative and must be observed.

NOTE!













In addition to reading these Manual, please have your specialized dealer explain your firearm and train you in its use.

4.1. IMPORTANT PRINCIPLES

NOTE!



It is expressly recommended that you never use firearms under the influence of drugs, alcohol or medications. Your sight, dexterity, and judgment may be compromised. Good physical and mental health is the prerequisite for the use of a firearm. (Please also heed the currently valid legal framework.)

-  The use of a firearm is exclusively permitted for proper use.
-  Firearms owners are responsible for ensuring that their firearm is always, and especially during their absence, never within reach of and secure against access by children and other unauthorized persons.
-  Weapons may never be given to unauthorized persons.
-  Only original ANSCHÜTZ magazines may be used.
-  The specified capacity of the magazine may never be exceeded.
-  Changes to the rifle or the use of non-original ANSCHÜTZ magazines and accessories may cause malfunctions.
-  Severe and life-threatening injuries and damage can be caused by the use of incorrect ammunition, soiling in the barrel or incorrect cartridge components.
-  Firearms that exhibit safety-compromising changes may not be used. If you determine a defect or failure, the firearm must be unloaded and brought to an authorized gunsmith for repair.
-  In case of external effects (e.g., corrosion, dropping, etc.), the firearm must be checked by an authorized gunsmith.
-  A firearm must always be handled with the greatest of care and secured against falling.

4.2. SHOOTING

⚠ WARNING!

Peril to life and causing of property damage! Aiming with the muzzle at people and objects.

- ▶ When the firearm is not being used, hold the muzzle in a safe direction.
- ▶ A muzzle may never be held in a direction in which it can cause damage or endanger life.

⚠ CAUTION!

Malfunction when shooting!
Shot did not release when the trigger was pulled.

- ▶ Do not look into the muzzle.
- ▶ Hold the muzzle in a safe direction.
- ▶ Unload the firearm.
- ▶ Remove residues from the barrel.

- ⚠ When ready to fire, never hold the muzzle of a firearm under water or on materials or objects in order to prevent an accident or damage to your rifle.
- ⚠ Only shoot the caliber specified on the barrel of the firearm.
- ⚠ Only clean, factory-loaded, new ammunition in the caliber approved for the rifle may be used.
- ⚠ Ammunition must comply with the specifications of the C.I.P.
- ⚠ Only load the firearm immediately before use.
- ⚠ Only original ANSCHÜTZ magazines may be used.
- ⚠ The specified capacity of the magazine may never be exceeded.
- ⚠ The use of incorrect ammunition, soiling in the barrel or incorrect cartridge components can cause life-threatening injuries and property damage.
- ⚠ Only original ANSCHÜTZ parts may be used.

- ⚠ Every firearm must be treated as if it were loaded.
- ⚠ Never pick up a firearm by the trigger.
- ⚠ Shooting ranges must be sufficiently ventilated.
- ⚠ A bullet trap in the shooting range must be completely safe and visible.
- ⚠ When shooting, no people may linger near the target.
- ⚠ In case of poor visibility conditions, a firearm should not be used.
- ⚠ Do not shoot into the air, at hard or smooth surfaces, bodies of water, or targets on the horizon.
- ⚠ Do not shoot at targets off which the bullet can ricochet or be diverted.

GENERAL NOTES

4.3. MAINTENANCE

 Before and after use, or in case of maintenance and cleaning work, ensure that the firearm is not loaded.

4.4. TRANSPORT

 Firearms may only be transported unloaded and in locked containers.

 If you transport your firearm in a suitcase or a soft case, always make sure that the firearm and the inside of the suitcase or soft case are dry.

 Only transport weapons in a dry and clean condition.

4.5. STORAGE

 Firearms that are not in use must, in compliance with the currently applicable laws, be kept under lock and key.

 Firearms must always be stored unloaded and uncocked.

 Ammunition must be kept in a separate place under lock and key.

4.6. EAR AND EYE PROTECTION

NOTE!



When shooting, approved eye protection should be used for your safety! Shooting without safety equipment can cause vision damage.

NOTE!



When shooting, approved hearing protectors should be used for your safety! Shooting without safety equipment can cause hearing damage.

5. LAWS

NOTE!



The valid firearm laws, regulations, and provisions of the country in question as well as the safety rules of hunting and sports ordinances must be heeded.

6. PROPER USE

ANSCHÜTZ rifles are to be used exclusively for shoots and on shooting ranges (for sport and hunting disciplines) and may only be used by people with proper firearms permits.

NOTE!



The use of a firearm is exclusively permitted for proper use.

7. LIABILITY

J.G. ANSCHÜTZ GmbH & Co. KG assumes no liability or claims for damages of any type due to:

- Failure to follow these Manual
- Improper handling or repair
- Use of non-original ANSCHÜTZ parts
- Incorrect handling or maintenance
- Any type of carelessness
- Removal of seals or sealing lacquer
- Unauthorized interventions
- Transport damage that is not the fault of ANSCHÜTZ

can occur.

CAUTION!



Changes and manipulations to the firearm or its parts are prohibited and under some circumstances, may violate the guarantee provisions. Such changes can compromise the safe use of the product and cause accidents that put life and limb at risk. In such as case, the guarantee is automatically voided.

 Examine the firearm for changes before each use.

8. PRODUCT-SPECIFIC HANDLING

8.1. BOLT

NOTE!



For some models, the rifle and the bolt are packaged separately for safety reasons and must be put together.

NOTE!



Before first use of the firearm, the bolt and inside of the barrel must be de-oiled lint-free.

8.1.1. COCKING THE BOLT

The bolt [2] must be cocked so that it can be installed in the receiver [7]. If the bolt [2] has been removed from the receiver and uncocked for cleaning or inspection [7], bolt [2] must be cocked manually before it is installed again. Cock the bolt as follows:

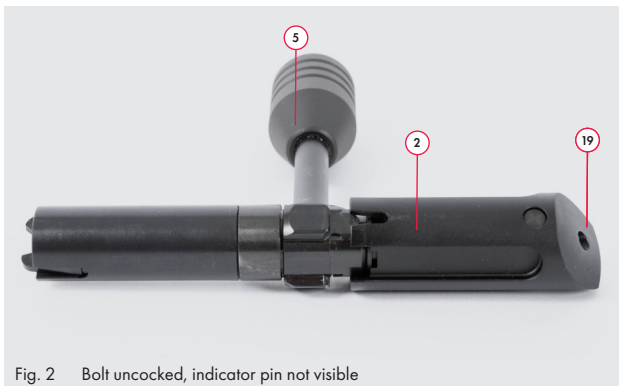

Fig. 2 Bolt uncocked, indicator pin not visible

- 19. Indicator pin
- 2. Bolt
- 5. Bolt handle

- ▶ Wipe excess oil from the bolt [2].

CAUTION!



Risk of injury!

- ▶ When cocking the bolt, make sure your fingers do not get caught!

- ▶ Hold the bolt handle [5] in your left hand, whereby it is pointing down. Hold the bolt [2] in your right hand and turn it upward.



Fig. 3 Bolt uncocked - indicator pin not visible

- ▶ The cocked bolt [2] is indicated by an indicator pin [19] protruding toward the back, with a red ring around it.



Fig. 4 Bolt cocked - indicator pin visible



Fig. 5 Bolt cocked - indicator pin visible

- ✓ The bolt [2] is now cocked and can be installed in the receiver [7].

8.1.2. INSERTING THE BOLT

⚠ WARNING!



Mortal danger!
Due to ammunition in chamber
or magazine.

- ▶ Make sure that no magazine is inserted
and there are no ammunition in the rifle.

⚠ CAUTION!



Property damage!

- ▶ When inserting the bolt, make sure not to
damage the stock.

ℹ NOTE!



To insert the bolt [2], the bolt catch [3] must
not be pressed.

- ▶ Place cocked bolt [2] on the receiver [7] and push the
bolt [2] forward up to the stud (direction of arrow).

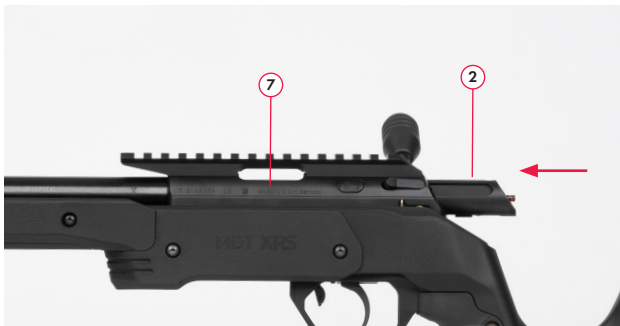

Fig. 6 Inserting the bolt

- ▶ Close the bolt [2], by pressing the bolt handle
downward [5].



Fig. 7 Closing the bolt

- ✓ The bolt [2] is inserted.
- ✓ The rifle is now cocked and ready to use.

8.1.3. REMOVING THE BOLT

⚠ CAUTION!



Property damage!

- ▶ When removing the bolt,
be sure not to damage the stock.

Here's how to remove the bolt:

- ▶ Lift up the bolt handle [5] (direction of arrow) and pull
it back.



Fig. 8 Lifting the bolt handle

- ▶ Hold the bolt catch [3] down and pull the bolt [2] out
of the receiver [7] in the direction of the arrow.

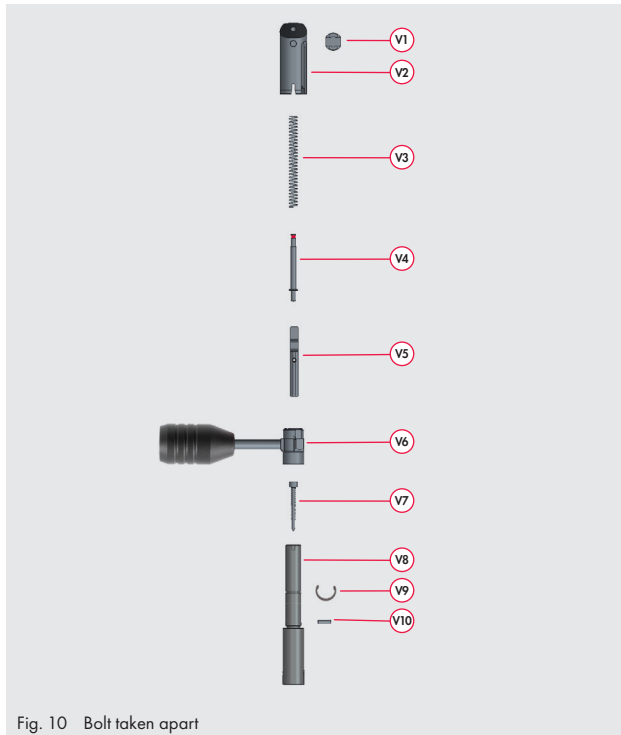

Fig. 9 Removing the bolt

- ✓ The bolt [2] is removed.

8.1.4. MAINTENANCE OF THE BOLT

8.1.4.1. COMPONENTS/DEFINITIONS



- | | |
|-----------------------|----------------------------------|
| V1. Locking button | V6. Bolt handle |
| V2. Receiver | V7. Firing pin with reset spring |
| V3. Firing pin spring | V8. Bolt body |
| V4. Indicator pin | V9. Half-moon ring |
| V5. Cocking piston | V10. Positioning pin |

8.1.4.2. DISASSEMBLING THE BOLT

WARNING!



Only by an authorized gunsmith!
 ▶ Failure to follow these instructions voids the guarantee and any claims for damages.

CAUTION



Risk of injury/property damage
 Component is under tension due to the installed spring.
 ▶ Caution, flying parts

- ▶ Remove the bolt [2] (See chapter "8.1.3. Removing the bolt" on page 10).
- ▶ Uncock the bolt [2] (turn the bolt handle [V6] counter-clockwise in the direction of the arrow to the left).



- ✓ The indicator pin protruding in the cocked state penetrates completely into the inside of the bolt.
- ▶ Press the receiver [V2] in the direction of the action lug up to the stud



- ▶ Turn the locking button [V1] 90° with a screwdriver, nickel or similar object.



Fig. 15 Locking button [V1] and screwdriver

- ▶ Pull of the receiver [V2] toward the back.
- ▶ Pull out the firing pin spring [V3] and indicator pin [V4].
- ▶ Remove the cocking piston [V5].



Fig. 16 Remove the cocking piston [V5]

- ✓ The bolt [2] is now disassembled and can be cleaned.

NOTE!



Clean dirt and powder residues from all parts of the disassembled bolt with a thin, non-resinous oil. Then coat the components of the bolt with a light oil film.

8.1.4.3. REMOVING THE FIRING PIN

WARNING!



Only by an authorized gunsmith!

- ▶ Failure to follow these instructions voids the guarantee and any claims for damages.

- ▶ Remove the half-moon ring [V9].
- ▶ Remove the bolt handle [V6] toward the back.
- ▶ Remove the positioning pin [V10].
- ▶ Remove the firing pin [V7] incl. reset spring.

NOTE!



Clean dirt and powder residues from all parts of the disassembled bolt with a thin, non-resinous oil. Then coat the components of the bolt with a light oil film.

8.1.4.4. ASSEMBLING THE BOLT

- ▶ Assembly is done in the reverse order. (See chapter "8.1.4.2. Disassembling the bolt" on page 11)
- ▶ Turn the firing pin [V7] in the direction of the and reset spring to the "touch hole" position.
- ▶ Mount the stud pin [V10]
- ▶ Mount the bolt handle [V6]
- ▶ Mount the half-moon ring [V9] (caution: the position must match the receiver [V2])
- ▶ Inserting the cocking piston [V5]
- ▶ Inserting the indicator pin [V4]
- ▶ Inserting the firing pin spring [V3]
- ▶ Replacing the receiver [V2]
- ▶ Press receiver [V2] against the firing pin spring [V3] in the direction of the action lug up to the stud and turn the locking button 90° with a screwdriver, nickel or similar object.

NOTE!



The completely assembled bolt must be cocked before inserting it into the receiver. Cock the bolt. (See chapter "8.1.1. Cocking the bolt" on page 9)

NOTE!



ANSCHÜTZ recommends having the headspace checked by an authorized gunsmith at regular intervals.

8.1.4.5. MAINTENANCE INTERVALS FOR THE BOLT

For optimal performance, ANSCHÜTZ recommends having the firing pin springs replaced by an authorized gunsmith every 5 years or after shooting 50,000 shots.

8.2. SETTING/RELEASING THE SAFETY

NOTE!



The rifle's safety can only be set/released, e.g., with open bolt (firing pin cocked) or after the loading process/closed bolt (firing pin and trigger cocked). The general process "setting/releasing the safety" will be described below.

8.2.1. SETTING THE SAFETY

- ▶ Push the safety catch [4] to the back (in the direction of the arrow). The red dot is not visible).

NOTE!



The safety catch must catch in a notch exactly and may not be between the end stops.



Fig. 17 Safety catch "safe"

- ✓ The firearm is cocked and the safety set.
- ☞ The indicator pin [19] is visible.

8.2.2. RELEASING THE SAFETY

- ▶ Put the safety catch [4] in fire position (direction of the arrow). The red dot is visible.

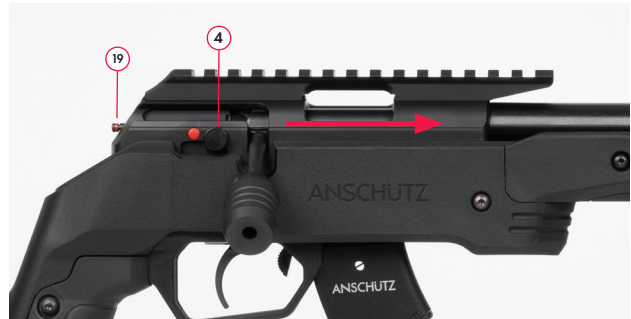

Fig. 18 Safety catch "ready to fire" (red dot visible)

- ✓ The firearm is cocked, the safety released, and ready to fire.
- ✓ The red dot is visible.

8.3. LOADING/REPEATING/SHOOTING/UNLOADING

8.3.1. LOADING THE MAGAZINE

WARNING!



Mortal danger!
Incorrect caliber in the magazine.

- ▶ Only use the caliber specified on the barrel.

CAUTION!



Only use ammunition with a muzzle speed V_0 of at least 280 m/s (920 fps). Failure to follow these instructions shall mean that the manufacturer assumes no liability and it voids the guarantee.

- ▶ Open the bolt [2].
- ▶ Set the firearm's safety! (See chapter "8.2.1. Setting the safety" on page 13).

- ⚠ Only load the firearm immediately before use.

CAUTION!



Property damage!
After unlocking the safety, the magazine can fall out of the magazine guide of its own accord.

- ▶ While unlocking the magazine, hold a hand under the magazine.

- ▶ Press the magazine release lever [16] forward (in the direction of the arrow).

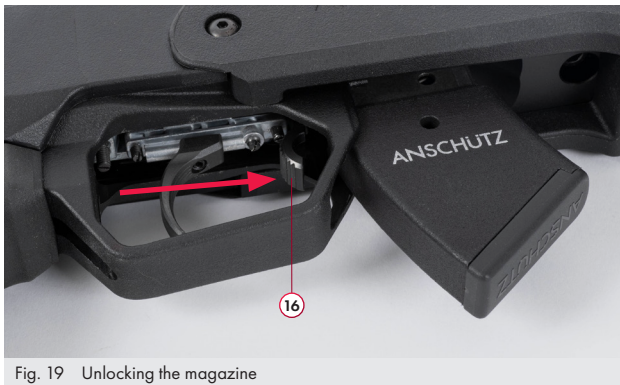

- ✓ The magazine [17] is unlocked and can be removed.
- ▶ Use your hand to pull the magazine [17] out of the magazine guide.

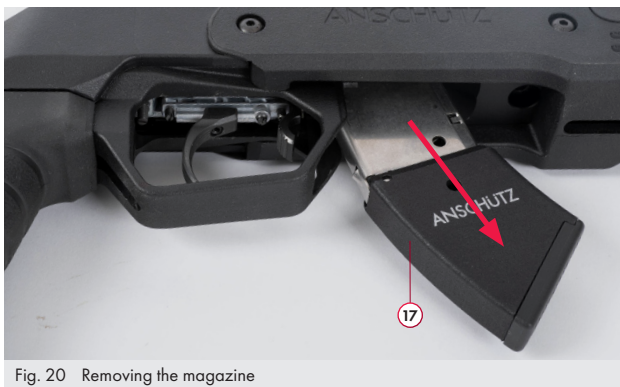

- ▶ Cartridges with cartridge rim in front, set in the middle of the red feeder.



- ▶ Press the feeder downward with the cartridge and push the cartridge into the magazine [17].



- ✓ The magazine [17] is loaded.

- ⚠ Only original ANSCHÜTZ magazines may be used.
- ⚠ The specified capacity of the magazine may never be exceeded.
- ⚠ Only cartridges of the caliber specified on the barrel may be used.
- ⚠ Only clean, factory-loaded, new ammunition in the caliber approved for the rifle may be used.
- ⚠ Ammunition must comply with the specifications of the C.I.P.

- ▶ Insert the magazine [17] into the firearm (in the direction of the arrow) until it audibly catches in a notch.

- ☛ For easier handling, you can press the magazine release lever parallel to this. The magazine then slides into the magazine guide with much less resistance.



- ☛ The firearm is loaded, cocked and the safety set.

8.3.2. REPEATING

⚠ WARNING!

⚠ Mortal danger!
Unintentional shooting due to loaded, unsecured firearm.

- ▶ Hold the muzzle in a safe direction.
- ▶ After loading, set the firearm's safety.

⚠ WARNING!

⚠ Mortal danger!
Unintentional shooting due to inattention when setting the firearm's safety or possible malfunctions after setting the safety.

- ▶ Even when the safety is set, the muzzle may never be held in a direction in which it can cause damage or endanger life.

This rifle is a repeater, which feeds the ammunition directly from the loaded magazine. If you actuate the bolt, an armed cartridge is fed from the magazine into the chamber and the shot cartridge case is ejected first.

📌 NOTE!

! Any cartridge still in the chamber will be ejected.

- ▶ If the bolt [2] is not open, open the bolt [2].
- ▶ Lift up the bolt handle [5] and pull the bolt [2] up to the stud against the bolt catch [3].

📌 NOTE!

! By opening the bolt, the firing pin is cocked.

- ▶ Push the bolt [2] forwards and close the bolt [2]. This pushes the next cartridge out of the magazine [17] into the chamber.



Fig. 24 Closing the bolt

- ▶ Make sure you act calmly and avoid shocks so that the cartridge does not fall out of the bolt body when closing.



Fig. 25 The firearm is loaded, cocked, and the safety set

- ✓ The firearm is now loaded, cocked, and the safety set.

8.3.3. READY TO FIRE

⚠ WARNING

⚠ Mortal danger!

- ▶ Make sure that there is space in front of and behind you.
- ▶ Make sure that you have an appropriately safe bullet trap.
- ▶ Load and release the safety on your rifle only immediately before you are ready to fire.
- ▶ Set the safety or unload the rifle after shooting.

- ▶ The rifle is ready to fire after (See chapter "8.3.1. Loading the magazine" on page 13) and (See chapter "8.3.2. Repeating" on page 15). To shoot, actuate the safety catch [4] on the rifle and then carefully aim at the target and pull the trigger [15].

- ▶ To shoot again, lift up the bolt handle [5] and pull the bolt [2] up to the stud against the bolt catch [3].
- ▶ The cartridge in the receiver [7] is ejected. By closing the bolt [2] again, the next cartridge slides out of the magazine [17] into the chamber.

NOTE!



By closing the bolt, the cartridge is fed into the chamber.

WARNING!



Mortal danger!
Unintentional shooting due to loaded, unsecured firearm.

- ▶ Hold the muzzle in a safe direction.
- ▶ After loading, set the firearm's safety.

WARNING!



Mortal danger!
Unintentional shooting due to inattention when setting the firearm's safety or possible malfunctions after setting the safety.

- ▶ Even when the safety is set, the muzzle may never be held in a direction in which it can cause damage or endanger life.

8.3.4. UNLOADING/MAKING READY FOR STORAGE

It is recommended that you keep the rifle with uncocked bolt. This extends the life span of the firing pin spring and maintains reliable firing of the cartridge. Follow the steps below to make the repeater ready for storage.

- ☛ It is possible to load and unload this rifle in the safe position.

WARNING!



Mortal danger!
Unintentional shooting due to loaded, unsecured firearm.

- ▶ Hold the muzzle in a safe direction.
- ▶ Make sure that there is no ammunition in the magazine and the chamber before you perform this procedure.

NOTE!



Any cartridge still in the chamber will be ejected.

Make sure that there are no ammunition in the magazine [17], the receiver, [7] or in the chamber.

Check this as follows:

- ▶ Lift up the bolt handle and set the safety immediately.
- ▶ Make sure that the safety catch [4] is on "safe" (the red dot is not visible).
- ▶ Pull the bolt [2] up to the stud against the bolt catch [3].



Fig. 26 Opening the bolt

- ▶ Press the magazine release lever [16] forward (in the direction of the arrow).

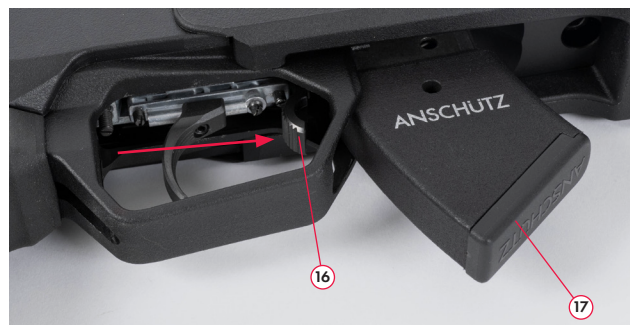

Fig. 27 Pushing the magazine release lever forward



Fig. 28 Removing the magazine

- ✓ The magazine [17] is unlocked and can now be removed.
- ✎ Before the next steps, check the magazine [17], the receiver [7], and the chamber.

⚠ CAUTION!



Property damage!
After unlocking the safety, the magazine can fall out of the magazine guide of its own accord.

- ▶ While unlocking, hold a hand under the magazine.

- ▶ Put the safety catch [4] in fire position (direction of the arrow).
- ✓ The red dot is visible.
- ▶ Hold the rifle in a safe direction and pull the trigger [15] to the rear position. This is best done with your left hand.
- ▶ Push the bolt [2] carefully forwards and close the bolt handle [5] slowly. This way, the firing pin inside the bolt [2] can move safely forward and it reduces the pressure of the firing pin spring.



Fig. 29 Pushing the safety catch forward (releasing the safety)

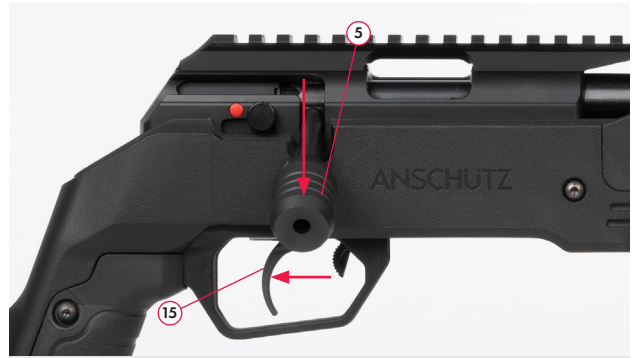

Fig. 30 Closing the bolt

- ✎ The red indicator pin is not visible.
- ✓ The firearm is now uncocked, unloaded, and ready for transport and storage.

MANUAL TRIGGER 5061 (D) APR

8.4. TRIGGER

8.4.1. SINGLE STAGE 5061 D APR AND TWO STAGE TRIGGER 5061 APR

Delivery state:

- ✦ The trigger 5061 APR D is delivered from the factory as a single stage trigger with a set trigger weight of 750 g.
- ✦ The trigger 5061 APR is delivered from the factory as a two stage trigger with a set trigger weight of 750 g.

If your rifle has an adjustable trigger blade, you can adjust it as follows.

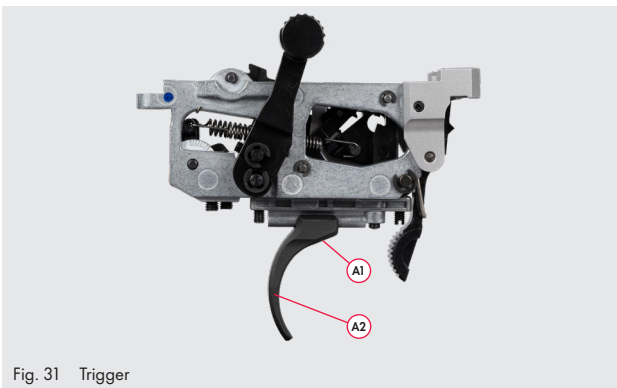

Fig. 31 Trigger

- A1. Adjustment screw for trigger blade A2. Trigger blade

8.4.2. SETTING THE TRIGGER

8.4.2.1. ADJUSTING THE TRIGGER BLADE

- ▶ Unscrew the trigger blade adjustment screw [A1] (2 mm hexagon screw), trigger blade [A2] can be pushed lengthwise along the guide and angled to the side.

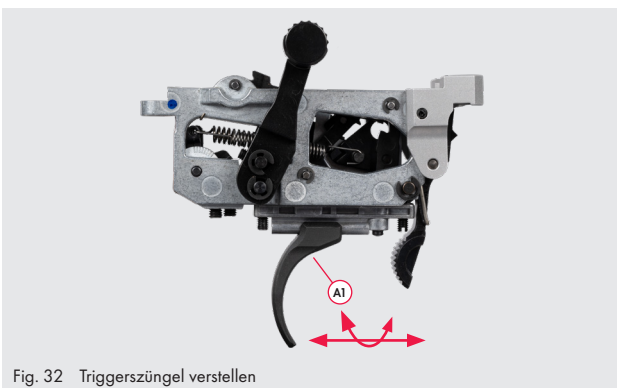

Fig. 32 Triggerszüngel verstellen

- ▶ Tighten the trigger blade set screw [A1] again. (2 Nm)
- ✓ Trigger blade [A2] and angle are set.

8.4.3. MAINTENANCE OF THE TRIGGER

- ✦ Please heed the general maintenance notes!
- ▶ Keep trigger dry and dust-free (the release links were coated with long-lasting grease by ANSCHÜTZ).
- ▶ Never wash out the insides of the trigger with a spray or oil to prevent hardening, sticking or soiling of the trigger parts.
- ⚠ When maintaining the firearm no dirt, solvent residues, greases or unsuitable oils may get into the trigger assembly.

8.4.4. CHECKING THE TRIGGER FASTENING

ANSCHÜTZ recommends to have the trigger checked by an authorized gunsmith at least once a year. The trigger mounting screws should also be checked for tightness.

8.5. BARRELED ACTION MOUNTING AND STOCK SETTINGS

8.5.1. COMPONENTS / DEFINITIONS

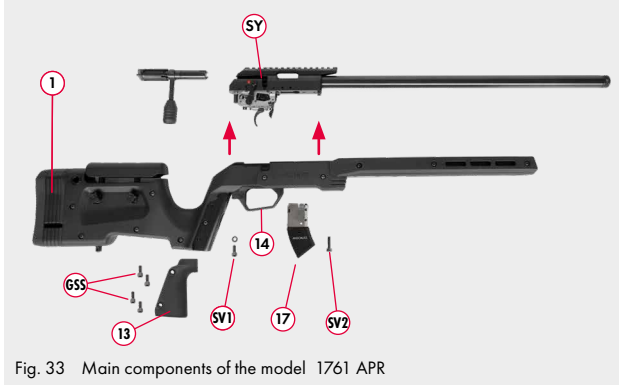

Fig. 33 Main components of the model 1761 APR

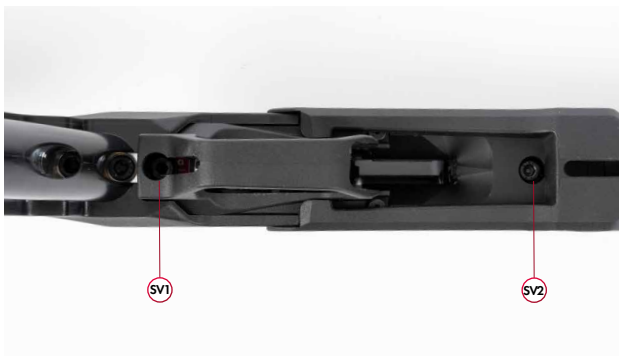

Fig. 34 Main components of the model 1761

- | | |
|----------------------|---------------------------|
| 1. Stock | 17. Magazine |
| 14. Trigger guard | GS. Interchangeable grips |
| GSS. grip screws | SV1. Bedding screw 1 |
| SV2. Bedding screw 2 | SY. Barreled action |

8.5.2. MOUNTING / DISMOUNTING THE STOCK AND BARRELED ACTION

- ▶ Check the state of the rifle.
- ▶ Remove the bolt and the magazine [17].
- ▶ Dismount grip [13] by removing the grip screws [GSS]. (See chapter „8.5.3.3. Change grips“ on page 20)
- ▶ Loosen and remove both barreled action bedding screws [SV1] and [SV2] (hex key 4).
- ▶ Take barreled action [SY] out of the stock [1].
- ▶ The connection of stock and barreled action is done in the reverse order.

⚠ Tighten both barrel action bedding screws [SV1] and [SV2] and tighten them in alternation and evenly step by step (hex key 4, 5 Nm).

⚠ Place the chamfered washer on [SV1] so that the chamfered side faces the stock and system when screwing in. The non-beveled side is on the side of the screw head.

NOTE!



After initial mounting of the barreled action, settling of the bolt wood may occur. That's why ANSCHÜTZ recommends tightening the bedding screws after a while.

⚠ The barreled action fastening must be checked to ensure it is tight each time before you shoot.

8.5.3. STOCK ADJUSTMENTS

NOTE!



Do not tighten the fastening screws too tightly to prevent damage to the threads.

8.5.3.1. ADJUSTMENT OF THE BUTT PLATE

- ▶ Unscrew the screw on the back side of the butt plate.



Fig. 35 Loosening the screw

- ▶ You can now remove or add butt plate spacers.



Fig. 36 Spacers can be removed or added

- ▶ Tighten the screw with 2.5 Nm.
- ✓ The butt plate is adjusted.

8.5.3.2. ADJUSTMENT OF THE CHEEK PIECE

- ▶ Open both screws on the right hand side on the back of the stock.



- ▶ The cheek piece can now be moved upwards or downwards.



- ▶ Once the correct height has been set, tighten the screws again by hand.
- ✓ The cheek piece is adjusted.

8.5.3.3. CHANGE GRIPS

Two grip plates are included with your MDT XRS stock.

- ▶ Remove the screws on both sides of the handle.

⚠ You will need an imperial inch hex wrench.



- ▶ Now the handle can be pulled off.



- ▶ The assembly is carried out in reverse order.
- ✓ The handle is mounted.

8.5.4. MAINTENANCE / CLEANING OF THE STOCK

- ⚡ Please heed the general maintenance notes!

It is important to keep the stock clean and free of moisture. If your stock should get wet, we recommend cleaning it with a soft cloth and drying it completely. For this, it may be appropriate to dismount the stock and barreled action.

! NOTE!



Firearm oils are not suitable for stock maintenance. Use appropriate stock care products and note the instructions of the manufacturer in question.

! NOTE!



Keep the stock dry, free of water, and avoid condensation formation. Pay attention that the stock does not come into contact with any solvents, cleaning products or other substances. Do not affix any stickers or other objects to the stock. This can cause damage to the stock surface.

! NOTE!



Please note the cleaning instructions, the care products, and follow the instructions of the manufacturer in question.

8.6. BARREL / BARREL THREAD

8.6.1. DISMOUNTING / MOUNTING THE BARREL THREAD

If you want to clean the barrel thread and threaded bushing of an ANSCHÜTZ rifle, proceed as follows.

- ▶ Unscrew the threaded bushing from the barrel thread.



Fig. 41 Unscrewing the threaded bushing

- ▶ Clean the barrel thread with a soft, lint-free cloth and a suitable cleaning solution.



Fig. 42 Cleaning the threads



Fig. 43 Coating with ceramic lubricant

- ✓ The barrel thread is clean.
- ▶ Clean the threaded bushing with a soft, lint-free cloth and a suitable cleaning solution.



Fig. 44 Cleaning and oiling the threaded bushing

- ✓ The threaded bushing is clean.
- ▶ Mounting of the threaded bushing is done in the reverse order.

8.6.2. MAINTENANCE OF THE BARREL

- Please heed the general maintenance notes!

8.6.2.1. CLEANING THE BARREL

⚠ CAUTION!



Never pull the brush back and forth in the barrel.

! NOTE!



Heed the Manual of the cleaner!

! NOTE!



After using cleaning agents that contain ammonia, be sure to re-oil the barrel to prevent the risk of corrosion.

To clean the barrel [9] in case of light soiling, use a plastic brush.

- ▶ Oil the plastic brush slightly and push from the chamber side out with a suitable cleaning rod through the barrel [9].
- ▶ To clean the barrel [9] in case of heavy soiling, use a bronze brush and a suitable barrel cleaner.

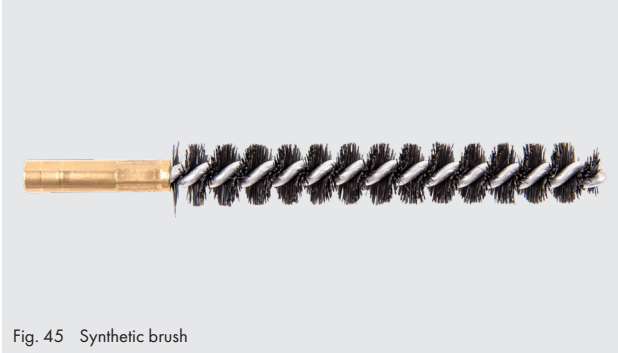

Fig. 45 Synthetic brush

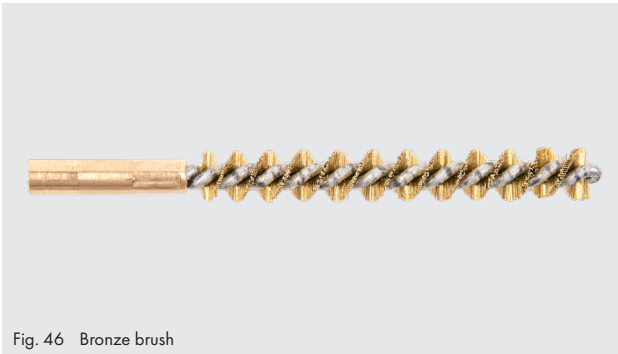

Fig. 46 Bronze brush

- ▶ To dry the barrel, pull a woolen swab through the barrel [9] several times.
- ✓ The barrel [9] is clean.

NOTE!



After using cleaning agents containing ammonia, be sure to re-oil the barrel to avoid the risk of corrosion.

8.7. SIGHTS / MOUNTING

8.7.1. MOUNTING A PICATINNY RAIL

All 1761 APR models are equipped with a Picatinny rail with 30 MOA pre-tilt. This is already mounted at the factory. To mount/dismount, follow the steps below:



Fig. 47 The last screw must sit in the clearance after mounting!

- ▶ Open the screws. Unscrew rear screw far enough!
- ▶ Slide the Picatinny rail onto the prism rail from the rear to the front or pull it off to the rear.



Fig. 48 Pushing on the Picatinny rail

- ▶ If the rail is in position, carefully tighten the last screw and make sure that it is screwed into the clearance.
- ▶ Carefully tighten the screw screws with 2.5 Nm.

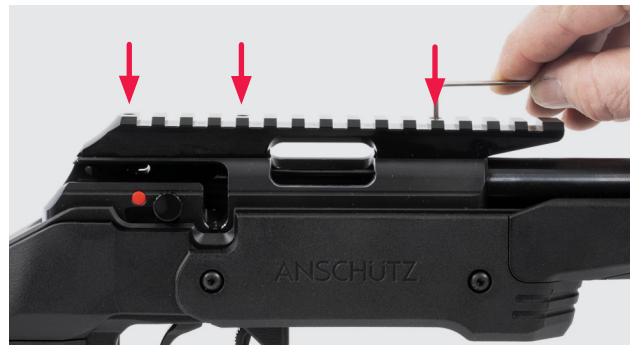

Fig. 49 Tightening the screws

- ✓ The Picatinny rail is mounted.

9. MAINTENANCE / CLEANING

9.1. GENERAL

WARNING!



Mortal danger!

Mortal danger! due to loaded firearm.

- ▶ Before use, or in case of maintenance and cleaning work, ensure that the firearm is not loaded. It is recommended that you remove all live ammunition from the work area when you are performing maintenance work on the rifle.

WARNING!



Bodily injury or property damage!
Risk of bodily injury or property damage due to unoiled barrel and chamber.

- ▶ Before shooting, the barrel and the chamber must be free of foreign bodies.

CAUTION!



Any changes or damage to the firearm should always be heeded. In case of a change or damage, the firearm must be brought immediately to an authorized gunsmith or sent to ANSCHÜTZ for inspection.

NOTE!



Protect the firearm against dust, sand, moisture, heat, and damaging influences.

NOTE!



In order to reduce the risk of stock breaks during transport, ANSCHÜTZ recommends, especially for flights, detaching the barreled action from the stock.

NOTE!



Please clean your rifle – especially the bolt and the barrel – after each use if you are using a sound moderator. Also follow the cleaning instructions of the manufacturer of your sound moderator!

NOTE!



Dry firing:

For safety, during dry firing, please always use a buffer cartridge to prevent damage!

NOTE!



When cleaning plastic parts (e.g., magazine floors, feeder), use only oils that do not damage, attack or destroy the plastic!

NOTE!



The rifle case/soft case should be cleaned and freed of dust and lint regularly.

The rifle case and soft case should have a smooth, dust-resistant inner lining.

When the rifle is not being used, the rifle case/soft case should always be open in order to allow moisture to escape.

The insertion of a moisture trap can reduce moisture formation.

NOTE!



Keep the stock dry, free of water, and avoid condensation formation. Pay attention that the stock does not come into contact with any solvents, cleaning products or other substances.

Do not affix any stickers or other objects to the stock. This can cause damage to the stock surface.

! NOTE!



If nothing else is specified, please tighten screws only hand-tight to prevent damage!

! NOTE!



When inserting the bolt, make sure not to damage the stock! Incorrect handling and inattention do not constitute a warranty case.

! NOTE!



After each use of the firearm, coat the steel parts with a thin oil film and clean the barrel thoroughly.

When transporting from cold to warm rooms, condensation can form on metal parts and inside the barrel. If this condensation is not dried off quickly, it can cause flash rust under some circumstances.

No other tools (felt stoppers, unapproved greases, etc.) may be used for cleaning the barrel.

9.2. MAINTENANCE INTERVALS

9.2.1. BEFORE SHOOTING

- Remove oil from the firearm carefully.



Removing oil from the firearm should be done at room temperature since at cold temperatures, too much residue may remain in the barrel.

- Shoot one to two shots to restore even shooting performance (oil shots).

9.2.2. AFTER SHOOTING

- Allow the firearm to warm up to room temperature with the bolt and snow cover (if present) open.
- Carefully remove sweat from external parts.
- Take the firearm apart and clean sweat off individual parts as well.
- Oil firearm with suitable gun oil, oil stock with special stock care products.
- Clean the barrel with a plastic brush and gun oil.

For new rifles (up to 100 shots) in 10-shot intervals, following in min. 50-shot intervals

- Clean the barrel from the chamber to the muzzle with a brass or bronze brush with suitable barrel cleaner.



Do not pull the brush back and forth in the barrel.

- Unscrew brass brush outside the muzzle and pull the cleaning rod carefully back through the barrel.
- Pull the cotton wick several times dry through the barrel until the last cotton wick no longer indicates any noticeable soiling.
- Wipe off the firearm (incl. stock) with an oily cloth.

9.2.3. ANNUALLY

- Have the firearm checked once a year by an expert who has received training from ANSCHÜTZ about the maintenance of ANSCHÜTZ firearms!

10. TROUBLESHOOTING

⚠ CAUTION!



In case of malfunction (shots not fired, etc.), the rifle must be unloaded, the safety set, and it must be brought to a specialized dealer/gunsmith or sent to ANSCHÜTZ.

11. DISPOSAL



Disposal of the firearm must be done demonstrably by a specialized dealer/gunsmith.

12. MISCELLANEOUS

Additional information is available on the Internet at www.anschuetz-sport.com.

ANSCHÜTZ will also be glad to inform you about news about this and other products with the ANSCHÜTZ newsletter, to which you can subscribe for free on the Internet.

Included with your firearm is a quality control card with the original test fire group.



Fig. 50 Control card shot with premium hunting ammunition (Fig. similar)

ⓘ NOTE!



Please wash your hands for hygienic reasons each time after you use the rifle, as there can be oils, greases, and contamination on the rifle.

13. SHOOTING PERFORMANCE

The shooting performance of a rifle depends on many factors. An important factor here is the ammunition. Not every barrel shoots equally well with every type of ammunition; there can be significant differences in performance.

The sights and their mounting is just as important. Parallax, loose sighting, defects in the sighting adjustment, and non-optimal mounting are the most frequent causes of unsatisfactory shooting performance.

That's why only telescopic sights and mounts mounted by a specialist are used and the ammunition is coordinated with those on your rifle.

Even ammunition from the same maker and the same filling can produce different shooting performance and shooting patterns from batch to batch and rifle to rifle. With optimally selected ammunition, sights, and mounting, we guarantee the outstanding shooting performance of our rifles. See guarantee card.

Please also note that every attachment or accessory (regardless of the manufacturer), such as sound moderators, muzzle brakes, and sights contribute to the precision and shooting performance and can affect it.

ⓘ NOTE!



Every bolt is adapted to the associated rifle in order to achieve optimal shooting performance. This is why, and for safety, the bolts may not be exchanged.

14. GUARANTEE CARD

<p style="text-align: center;">ANSCHÜTZ EINFACH EINS WERDEN!</p> <p style="text-align: center;"><<< WARRANTY >>></p> <p>1. Material:</p> <p>This product has been released for sale after the product itself, its materials and individual components have been subjected to strict inspection, or the rifle has demonstrated its durability and function during test shooting. J.G. ANSCHÜTZ GmbH & Co. KG offers a full guarantee covering material and manufacturing faults (excluding broken stocks and springs) for a period of two years, provided that the fault can be shown to have been present at the time of handover of the product. No warranty claims will be accepted by J.G. ANSCHÜTZ GmbH & Co. KG for faults that are the result of improper use or unauthorised repairs. The item will either be repaired or replaced at our discretion. Claims for compensation - put forward for any legal reason whatsoever - are excluded.</p> <p>2. Shooting Performance:</p> <p>The purchaser undertakes to inform J.G. ANSCHÜTZ GmbH & Co. KG in writing of any faults detected in shooting performance within one month of purchase with the submission of their own shooting record. J.G. ANSCHÜTZ GmbH & Co. KG reserves the right to transfer the rifle to an independent agency for inspection (DEVA or a national ballistics office). Should such an agency confirm excellent shooting performance, J.G. ANSCHÜTZ GmbH & Co. KG is entitled to charge the purchaser the costs of the rifle inspection. The accepted warranties do not apply to rifle damage resulting from mechanical effects and improper use or care by the purchaser. The warranty is excluded if the rifle has been repaired or modified by unauthorised persons. Likewise, the warranty is cancelled when using reloaded ammunition or ammunition which is not CIP approved.</p> <p>In the event of a warranty/damage claim please enclose this card, completed and signed by your dealer, with the product.</p> <hr/> <p>J.G. ANSCHÜTZ GmbH & Co. KG · Jagd- und Sportwaffenfabrik Postfach 1128 · D-89001 Ulm/Germany · www.anschuetz-sport.com</p>
Serial-No.:
Date:
Bought at:

ANSCHÜTZ

EINFACH **EINS** WERDEN!

J.G. ANSCHÜTZ GmbH & Co. KG
Jagd- und Sportwaffenfabrik

Daimlerstraße 12 · 89079 Ulm / Germany

Fon +49 - (0)731 - 40 12 - 0

Fax +49 - (0)731 - 40 12 - 700

www.anschuetz-sport.com

www.facebook.com/OfficialAnschuetz

www.youtube.com/AnschuetzGmbH

www.instagram.com/AnschuetzGmbH

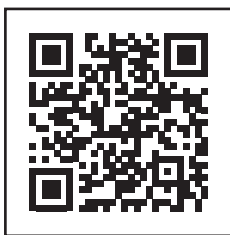

Production and model changes reserved · All colors and sizes approximate · Firearms that require a permit: Supply of firearms only to the holders of a purchasing permit ·
Firearms that do not require a permit: Supply only to persons over 18 years of age.
Misprints, errors, and prior sale also reserved © ANSCHÜTZ